

HIDRO 

ZAVRH *proizvodnja*
servis hidravlike

PROIZVODNJA

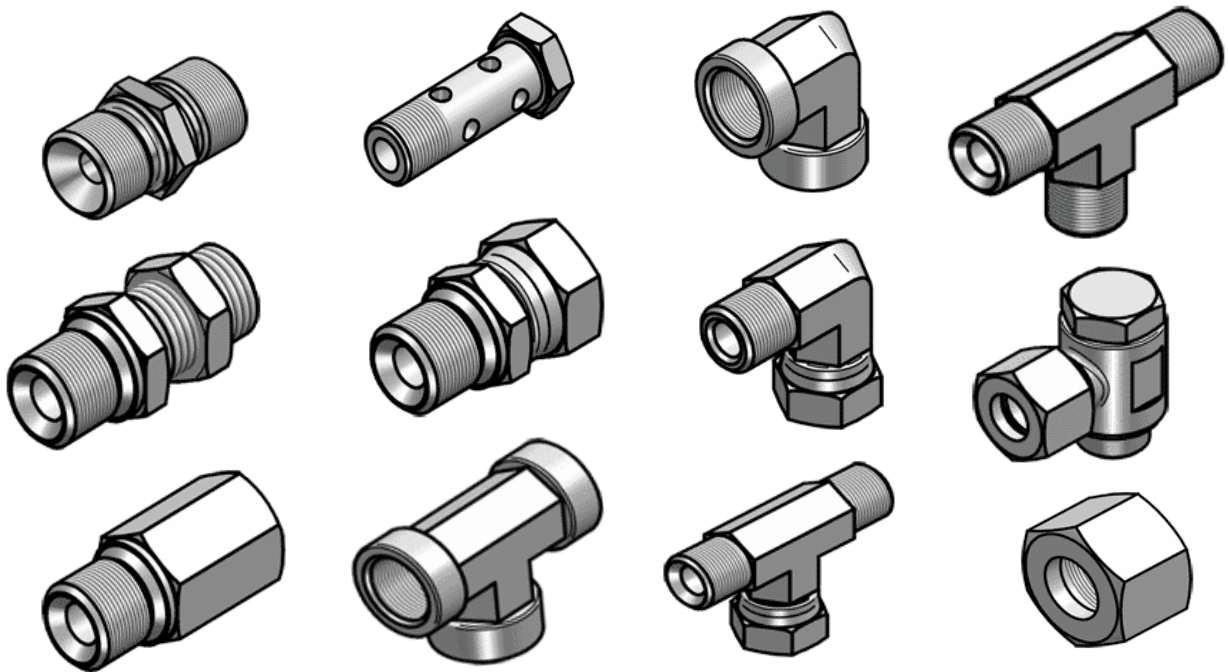

KATALOG PRIKLJUČKOV

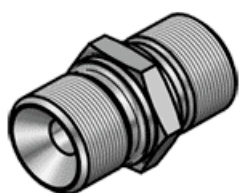
REDUCIRNI PRIKLJUČKI

NAZIV	NAVOJ	IDENT
Gr 1/4	1/4 – 1/4	1401419
Gr 3/8	3/8 – 3/8	1403819
Gr 1/2	1/2 – 1/2	1401214
Gr 5/8«	5/8 – 5/8	14058
Gr 3/4	3/4 – 3/4	1403414
Gr 1	1 - 1	1401010
Gr 5/4	5/4 – 5/4	1405411
Gr 6/4	6/4 – 6/4	1406464
Gr 2	2 - 2	1402020
Gr 3/8 – 1/4	3/8 – 1/4	1403814
Gr 1/2 – 1/4	1/2 – 1/4	1401213
Gr 1/2 – 3/8	1/2 - 3/8	1401238
Gr 5/8 – 1/2	5/8 – 1/2	1405812
Gr 3/4 – 3/8	3/4 – 3/8	1403438
Gr 3/4 – 1/2	3/4 – 1/2	1403412
Gr 1 – 1/2	1 – 1/2	1401012
Gr 1 - 3/4	1 – 3/4	1401034
Gr 5/4 – 3/4	5/4 – 3/4	1405434
Gr 5/4 - 1	5/4 - 1	1405410
Gr 6/4 – 5/4	6/4 – 5/4	1406454

REDUCIRNI PRIKLJUČKI M+Ž

NAZIV	NAVOJ	IDENT
Gr 1/4	1/4 – 1/4	1401420
Gr 3/8	3/8 – 3/8	1403820
Gr 1/2	1/2 – 1/2	1401220
Gr 3/4	3/4 – 3/4	1403420
Gr 1	1 - 1	1401020
Gr 5/4	5/4 – 5/4	301608
Gr 1/4 – 3/8	1/4 M – 3/8 Ž	301611
Gr 3/8 – 1/4	3/8 M – 1/4 Ž	301612
Gr 1/2 - 1/4	1/2 M - 1/4 Ž	301614
Gr 1/2 – 3/8	1/2 M - 3/8 Ž	301615
Gr 3/8 – 1/2	3/8 M - 1/2 Ž	301613
Gr 3/4 -1/2	3/4 M – 1/2 Ž	301617
Gr 1/2 – 3/4	1/2 M - 3/4 Ž	301616
Gr 1 – 3/4	1 M - 3/4 Ž	301618
Gr 1/4 – 1/4	1/4 Ž – 1/4 Ž	301802
Gr 3/8 – 3/8	3/8 Ž - 3/8 Ž	301803
Gr 1/2 – 1/2	1/2 Ž - 1/2 Ž	301804
Gr 3/4 – 3/4	3/4 Ž - 3/4 Ž	301806
Gr 3/8 – ½	3/8 Ž - 1/2 Ž	301813
Gr 1/4 – ½	1/4 Ž - 1/2 Ž	301614

KOTNI PRIKLJUČEK M+Ž

NAZIV	NAVOJ	IDENT
Gr 1/4	1/4 - 1/4	25924
Gr 3/8	3/8 - 3/8	25920
Gr 1/2	1/2 - 1/2	25921
Gr 3/4	3/4 - 3/4	25922
Gr 1	1 - 1	25923
Gr 5/4	5/4 - 5/4	306408
Gr 6/4	6/4 - 6/4	306409
Gr 2	2 - 2	306410

PREGRADNI KOTNI PRIKLJUČEK

NAZIV	NAVOJ	IDENT
Gr 1/4	1/4 - 1/4	305403
Gr 3/8	3/8 - 3/8	305405
Gr 1/2	1/2 - 1/2	305407
Gr 3/4	3/4 - 3/4	305409
Gr 1	1 - 1	305411
Gr 5/4	5/4 - 5/4	305413
Gr 6/4	6/4 - 6/4	305415

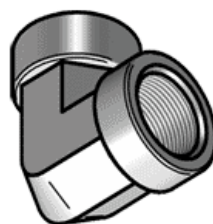
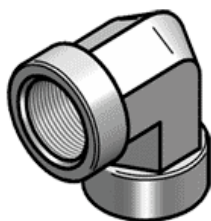
KOTNI PRIKLUČEK NOTRANJI NAVOJ

NAZIV	NAVOJ	IDENT
Gr 1/4 F+F	1/4 - 1/4	54090013
Gr 3/8 F+F	3/8 - 3/8	54090014
Gr 1/2 F+F	1/2 - 1/2	54090015
Gr 3/4 F+F	3/4 - 3/4	54090016
Gr 1 F+F	1 - 1	54090017

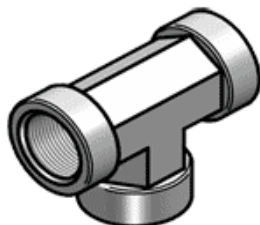
TROKRAKI PRIKLUČEK NOTRANJI NAVOJ

NAZIV	NAVOJ	IDENT
Gr 1/8 F+F+F	1/8 - 1/8	305001
Gr 1/4 F+F+F	1/4 - 1/4	54550021
Gr 3/8 F+F+F	3/8 - 3/8	54550022
Gr 1/2 F+F+F	1/2 - 1/2	54550023
Gr 3/4 F+F+F	3/4 - 3/4	54550024
Gr 1 F+F+F	1 - 1	54550025
Gr 6/4 F+F+F	6/4 - 6/4	305008

TROKRAKI PRIKLUČEK Z ZUNANJIM NAVOJEM

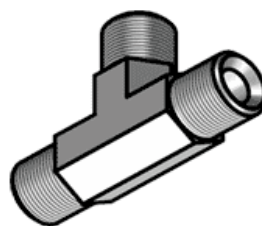
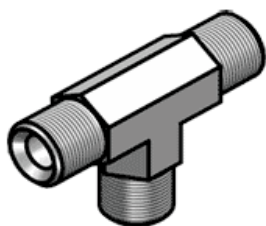

NAZIV	NAVOJ	IDENT
GR 1/4 M+M+M	1/4 – 1/4	54550011
GR 3/8 M+M+M	3/8 – 3/8	54550012
GR 1/2 M+M+M	1/2 – 1/2	54550013
GR 3/4 M+M+M	3/4 – 3/4	54550014

TROKRAKI PRIKLJUČEK Z ZUNANJIM NAVOJEM IN MATICO

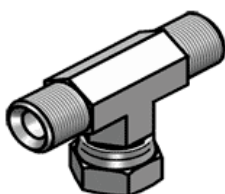

M+F+M - MATICA NA SREDINI T-KOS-a

M+M+F – MATICA NA ENI STRANI T-KOS-a

NAZIV	NAVOJ	IDENT
GR 1/4 M+M+F	1/4 – 1/4	54550015
GR 3/8 M+M+F	3/8 – 3/8	54550016
GR 1/2 M+M+F	1/2 – 1/2	54550017
GR 3/4 M+M+F	3/4 – 3/4	54550018
GR 1/4 -M+F+M	1/4 – 1/4	306802
GR 3/8 M+F+M	3/8 – 3/8	54550019
GR 1/2 M+F+M	1/2 – 1/2	54550020
GR 3/4 M+F+M	3/4 – 3/4	306806

RAVNI PRIKLJUČEK RI**RI »ZUNANJI NAVOJ«/«NOTRANJI NAVOJ«**

NAZIV	NAVOJ	IDENT
RI 1/8 – 1/4	1/8 – 1/4	107501
RI 1/4 – 1/4	1/4 – 1/4	25841
RI 3/8 – 1/4	3/8 – 1/4	107507
RI 1/4 – 3/8	1/4 – 3/8	107504
RI 3/8 – 3/8	3/8 – 3/8	458301
RI 1/2 – 3/8	1/2 – 3/8	25835
RI 3/8 – 1/2	3/8 – 1/2	107508
RI 1/4 – 1/2	1/4 – 1/2	107505
RI 1/2 – 1/2	1/2 – 1/2	25868
RI 3/4 – 1/2	3/4 – 1/2	25837
RI 1/2 – 3/4	1/2 – 3/4	107511
RI 3/4 - 1	3/4 - 1	107515
RI 1 – 1/2	1 – 1/2	25825
RI 1 – 3/4	1 – 3/4	25826
RI 1 – 5/4	1 – 5/4	25838
RI 5/4 - 1	5/4 - 1	25824
RI 6/4 - 1	6/4 - 1	107413
RI M18x1.5 - M18X1.5	M18X1.5 – M18X1.5	25839
RI M18X1.5 - 3/8	M18X1.5 – 3/8	107502
RI M20X1.5 – M16X1.5	M20X1.5 – M16X1.5	25831
RI 1/2 – M14X1.5	1/2 – M14X1.5	25810
RI 33X2 – 3/4	M33X2 – 3/4	25829
RI 33X2 – 1/2	M33X2 – 1/2	25823

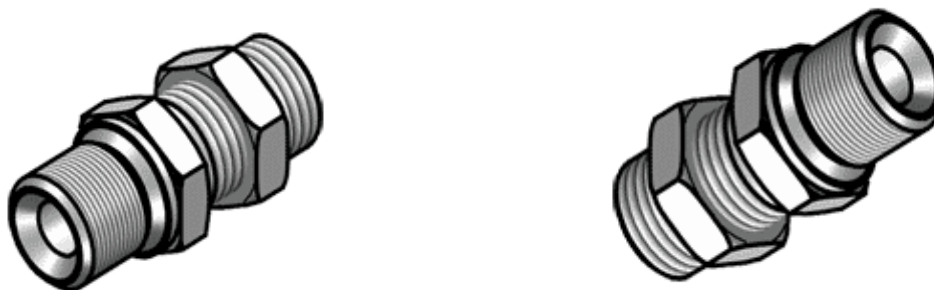
PREGRADNI PRIKLJUČEK**SV » DALJŠI NAVOJ«/»KRAJŠI NAVOJ«**

NAZIV	NAVOJ	IDENT
PREG.PRIKLJ.SV6-L	M12X1.5	25210
PREG.PRIKLJ. SV8-L	M14X1,5	25121
PREG.PRIKLJ. SV10-L	M16X1.5	25122
PREG.PRIKLJ. SV12-L	M18x1.5	25123
PREG.PRIKLJ. SV15-L	M22X1.5	25124
PREG.PRIKLJ. SV16-S	M24X1.5	25135
PREG.PRIKLJ. SV18-L	M26X1.5	25125
PREG.PRIKLJ. SV20-S	M30X2	25136
PREG.PRIKLJ. SV22-L	M30X2	25160
PREG.PRIKLJ. SV25-S	M36X2	25137
PREG.PRIKLJ.SV10L-M22X1.5	M16x1.5 – M22X1.5	25306
PREG.PRIKLJ SV12L-M22X1.5	M18x1.5 – M22X1,5	25123
PREG.PRIKLJ.SV3/8-1/2	3/8 – 1/2	25100121
PREG.PRIKLJSV 3/8-M22X1.5	3/8 – M22X1.5	25100122
PREG.PRIKLJ.SV 3/8	3/8 – 3/8	2510038
PREG.PRIKLJ. SV 1/2	1/2 – 1/2	2510012
PREG.PRIKLJ. SV3/4	3/4 – 3/4	2510034

VOTLI VIJAK

NAZIV	NAVOJ	IDENT
VOTLI VIJAK M10X1,25	M10X1,25	533926
VOTLI VIJAK M10X1	M10X1	533927
VOTLI VIJAK G1/4 - 24	G1/4 -24	533928
VOTLI VIJAK M12X1.5X30	M12X1,5	533929
VOTLI VIJAK M12x25	M12X1.5	533930
VOTLI VIJAK M14X1.5	M14X1.5	401414
VOTLI VIJAK M14X1.5 DVOJNI	M14X1.5	401514
VOTLI VIJAK R1/4	1/4	28852
VOTLI VIJAK M16X1.5	M16X1.5	533924
VOTLI VIJAK R3/8	3/8	401838
VOTLI VIJAK R3/8 DVOJNI	3/8	401738
VOTLI VIJAK M18X1.5	M18X1.5	401818
VOTLI VIJAK R3/8 - DVOJNI	3/8	401738
VOTLI VIJAK R1/2	1/2	533059
VOTLI VIJAK M22X1.5	M22X1.5	402222
VOTLI VIJAK R3/4	3/4	401840
VOTLI VIJAK M16X1.5 BREZ IZVRT.	M16X1.5	533925
VOTLI VIJAK M18X1.5 BREZ IZVRT.	M18X1.5	533931

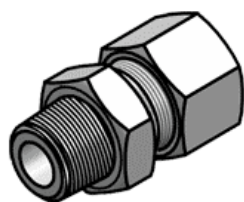
RAVNI PRIKLJUČEK SAMO TELESA BREZ MATIC IN TESNILNIH OBROČEV

NAZIV	NAVOJ	IDENT:
GE6-L M10X1	M12X1.5 / M10X	25300
GE6-L M12X.15	M12X1.5 / 12X1.5	25349
GE6-S M12X1.5	M14X1.5 / M12X1.5	25321
GE6-S M14X1.5	M14X1.5 / M14X1.5	25322
GE6-L R1/4	M12X1.5 / 1/4	25201
GE8-L M10X1	M14X1.5 / M10X1	25298
GE8-L M12X1.5	M14X1.5 / M12X1.5	25301
GE8-L M14X1.5	M14X1.5 / M14X1.5	25333
GE8-L M22X1.5	M14X1.5 / M22X1.5	25334
GE8-L R1/4	M14X1.5 / R1/4	25204
GE8-L R3/8	M14X1.5 / R3/8	25206
GE8-S R1/4	M16X1.5 / R1/4	25231
GE10-L M10X1	M16X1.5 / M10X1	25299
GE10-L M12X1.5	M16X1.5 / M12X1.5	25336
GE10-L M14X1.5	M16X1.5 / M14X1.5	25303
GE10-L M16X1.5	M16X1.5 / M16X1.5	25304
GE10-L M18X1.5	M16X1.5 / M18X1.5	25305
GE10-L M22X1.5	M16X1.5 / M22X1.5	25306
GE10-L R1/8	M16X1.5 / 1/8	25255
GE10-L R1/4	M16X1.5 / 1/4	25208
GE10-L R3/8	M16X1.5 / 3/8	25209
GE10-L R1/2	M16X1.5 / 1/2	25210
GE12-L M12X1.5	M18X1.5 / M12X1.5	25347
GE12-L M14X1.5	M18X1.5 / M14X1.5	25307
GE12-L M16X1.5	M18X1.5 / M16X1.5	25308
GE12-L M18X1.5	M18X1.5 / M18X1.5	25309
GE12-L M22X1.5	M18X1.5 / M22X1.5	25310
GE12-L R1/4	M18X1.5 / 1/4	25212
GE12-L R3/8	M18X1.5 / 3/8	25211
GE12-L R3/8 NPT	M18X1.5 / 3/8 NPT	25504
GE12-L R1/2	M18X1.5 / 1/2	25213
GE12-L R3/4	M18X1.5 / 3/4	25214
GE12-S M14X1.5	M20X1.5 / M14X1.5	25344
GE12-S M16X1.5	M20X1.5 / M16X1.5	25342
GE12-S M18X1.5	M20X1.5 / M18X1.5	25324

GE12-S R3/8	M20X1.5 / 3/8	25237
GE12-S R1/2	M20X1.5 / 3/8	25239
GE12-S R3/4	M20X1.5 / 3/4	25506
GE14-S M22X1.5	M22X1.5 / M22X1.5	25341
GE14-S R1/2	M22X1.5 / R1/2	25240
GE14-S R1/2 NPT	M22X1.5 / R1/2 NPT	25337
GE15-L M22X1.5	M22X1.5 / M22X1.5	25313
GE15-L R1/4	M22X1.5 / R1/4	25253
GE15-L R3/8	M22X1,5 / R3/8	25216
GE15-L R1/2	M22X1.5 / R1/2	25215
GE15-L R3/4	M22X1.5 / 3/4	25217
GE16-S M18X1.5	M24X1.5 / M18X1.5	25327
GE16-S M22X1.5	M24X1.5 / M22X1.5	25328
GE16-S M24X1.5	M24X1.5 / M24X1.5	25348
GE16-S M27X2	M24X1.5 / M27X2	25345
GE16-S R3/8	M24X1.5 / 3/8	25243
GE16-S R1/2	M24X1.5 / 1/2	25242
GE16-S R3/4	M24X1.5 / 3/4	25244
GE18-L M16X1.5	M26X1.5 / M16X1.5	25256
GE18-L M22X1.5	M26X1.5 / M22X1.5	25315
GE18-L R3/8	M26X1.5 / R3/8	25219
GE18-L R1/2	M26X1.5 / R1/2	25218
GE18-L R3/4	M26X1.5 / R3/4	25220
GE18-L R1	M26X1.5 / 1	25270
GE20-S M22X1.5	M30X2 / M22X1.5	25316
GE20-S M27X2	M30X2 / M27X2	25329
GE20-S R3/4	M30X2 / R3/4	25245
GE20-S R1	M30X2 / 1	25258
GE22-L M26X1.5	M30X2 / M26X1.5	25317
GE22-L R3/4	M30X2 / R3/4	25351
GE22-LR1	M30X2 / R1	25259
GE25-S M33X2	M36X2 / M33X2	25330
GE25-S R3/4	M36X2 / R3/4	25248
GE25-S R1	M36X2 / R1	25247
GE28-L R1	M36X2 / R1	25223
GE30-S M42X2	M42X2 / M42X2	25331
GE30-S R1	M42X2 / R1	25250
GE30-S R 1 1/4	M42X2 / R1 1/4	25249
GE35-L R1	M45X2 / R1	100552
GE35-L R1 1/4	M45X2 / R 1 1/4	107512
GE38-S M48X2	M52X2 / M48X2	100623
GE38-S R1 1/4	M52X2 / R1 1/4	100547
GE38-S R 1 1/2	M52X2 / R 1 1/2	100523
GE42-L R 1 1/4	M52X2 / R 1 1/4	100554

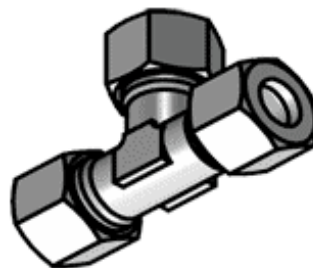
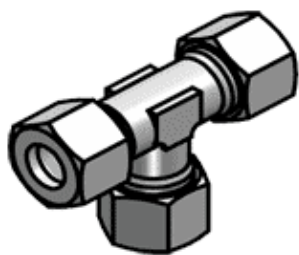
TROKRAKI PRIKLJUČEK

NAZIV	NAVOJ	IDENT
T 6-L	M12X1.5	25060
T 8-L	M14X1.5	25061
T 10-L	M16X1.5	25062
T 12-L	M18X1.5	25063
T 15-L	M22X1.5	25064
T 18-L	M26X1.5	25065
T 22-L	M30X2	25066
T 28-L	M36X2	25067
T 35-L	M42X2	25068
T 42-L	M52X2	25069
T 6-S	M14X1.5	25070
T 8-S	M16X1.5	25071
T 10-S	M18X1.5	25072
T 12-S	M20X1.5	25073
T 14-S	M22X1.5	25074
T 16-S	M24X1.5	25075
T 20-S	M30X2	25076
T 25-S	M36X2	25077
T 30-S	M42X2	25078
T 38-S	M52X2	25079

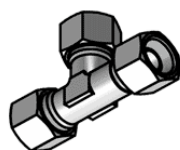
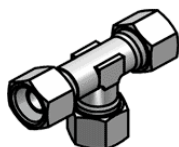
TROK.PRIKLJ. EVL

NAZIV	NAVOJ	IDENT
EVL 6-L	M12X1.5	604604
EVL 8-L	M14X1.5	604605
EVL 10-L	M16X1.5	25931
EVL 12-L	M18X1.5	25933
EVL 15-L	M22X1.5	604608
EVL 18-L	M26X1.5	604609
EVL 22-L	M30X2	25950
EVL 8-S	M16X1.5	25983
EVL 10-S	M18X1.5	604616
EVL 12-S	M20X1.5	25934
EVL 14-S	M22X1.5	604618
EVL 16-S	M24X1.5	604619
EVL 20-S	M30X2	604620

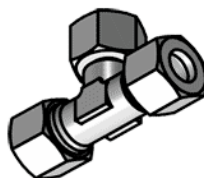
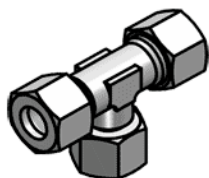
TROKRAKI PRIKLUČEK EVT MATICA NA SREDINI PRIKLUČKA

NAZIV	NAVOJ	IDENT
EVT 6-L	M12X1.5	605004
EVT 8-L	M14X1.5	25930
EVT 10-L	M16X1,5	605006
EVT 12-L	M18X1,5	25932
EVT 15-L	M22X1,5	605008
EVT 18-L	M26X1,5	605009
EVT 22-L	M30X2	605010
EVT 8-S	M16X1.5	25983
EVT 10-S	M18X1,5	604616
EVT 12-S	M20X1,5	605017
EVT 14-S	M22X1.5	605018
EVT 16-S	M24X1.5	605019
EVT 20-S	M30X2	605020

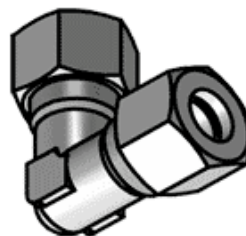
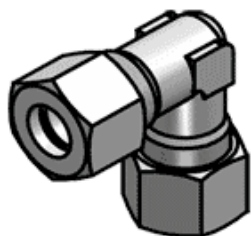
KOTNI PRIKLJUČEK SAMO TELESA W

NAZIV	NAVOJ	IDENT
W-6L	M12x1.5	25030
W 8-L	M14X1.5	25031
W 10-L	M16X1.5	25032
W 12-L	M18X1.5	25033
W15-L	M22X1,5	25034
W 18-L	M26X1.5	25035
W 22-L	M30X2	25036
W 28-L	M36X2	25037
W 35-L	M45X2	25038
W 42-L	M52X2	25039
W 6-S	M14X1.5	25040
W 8-S	M16X1.5	25041
W 10-S	M18X1.5	25042
W 12-S	M20X1.5	25043
W 14-S	M22X1.5	25044
W 16-S	M24X1.5	25045
W 20-S	M30X2	25046
W 25-S	M36X2	25047
W 30-S	M42X2	25048
W 38-S	M52X2	25049

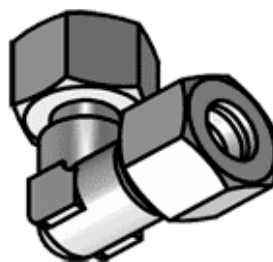
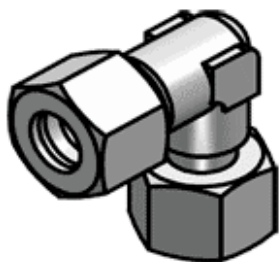
KOTNI PRIKLJUČEK Z MATICO EVW

NAZIV	NAVOJ	IDENT
EVW 6-L	M12X1.5	25900
EVW 8-L	M14X1.5	25901
EVW 10-L	M16X1.5	25902
EVW 12-L	M18X1.5	25903
EVW 15-L	M22X1.5	25904
EVW 18-L	M26X1.5	25905
EVW 22-L	M30X2	25906
EVW 28-L	M36X2	25907
EVW 35-L	M45X2	25908
EVW 42-L	M52X2	25909
EVW 6-S	M14X1.5	25910
EVW 8-S	M16X1.5	25911
EVW 10-S	M18X1.5	25912
EVW 12-S	M20X1.5	25913
EVW 14-S	M24X1.5	25914
EVW 16-S	M24X1.5	25915
EVW 20-S	M30X2	25916
EVW 25-S	M36X2	25917
EVW 30-S	M42X2	25918
EVW 38-S	M52X2	25919

RAVNI PRIKLJUČEK Z MATICO IN KONUSOM

NAZIV SAMO TELO	NAVOJ	TESNILNI OBROČ IDENT	MATICA IDENT:	TELESA IDENT
G 6-L	M12X1.5	27030	27001	25001
G 8-L	M14X1.5	27031	27002	25002
G 10-L	M16X1.5	27032	27003	25003
G 12-L	M18X1.5	27033	27004	25004
G 15-L	M22X1.5	27034	27005	25005
G 18-L	M26X1,5	27035	27006	25006
G 22-L	M30X2	27036	27007	25007
G 28-L	M36X2	27037	27008	25008
G 35-L	M45X2	27038	27009	25009
G 42-L	M52X2	27039	27010	25010
G 6-S	M14X1,5	27030	27011	25011
G 8-S	M16X1,5	27031	27012	25012
G 10-S	M18X1,5	27032	27013	25013
G 12-S	M20X1.5	27032	27014	25014
G 14-S	M22X1.5	27044	27015	25015
G 16-S	M24X1.5	27045	27016	25016
G 20-S	M30X2	27046	27017	25017
G 25-S	M36X2	27047	27018	25018
G 30-S	M42X2	27048	27019	25019
G 38-S	M52X2	27049	27020	25020

PRIKLJUČEK SWVE

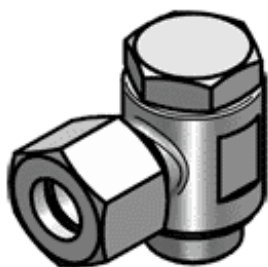

NAZIV	NAVOJ	IDENT
SWVE 6-L M10x1	M12X1.5 / M10X1	25876
SWVE 6-S R1/4	M14X1.5 / R1/4	25858
SWVE 8-L R1/4	M14X1.5 / R1/4	101305
SWVE 8-L M12x15	M14X1.5 / M12X1.5	101405
SWVE 10-L R1/4	M16X1.5 / R1/4	25853
SWVE 10-L M14X1.5	M16X1.5/M14X1.5	101406
SWVE 12-L R3/8	M18X1.5 / R3/8	25854
SWVE 12-S R3/8	M20X1.5 / R3/8	101317
SWVE 12-L M16x1.5	M18X1.5 / M16X1.5	25880
SWVE 12-S M16X1.5	M20X1.5 / M16X1.5	25880
SWVE 12-S M18X1.5	M20X1.5 / M18X1.5	101417
SWVE 15-L R1/2	M22X1.5 / R1/2	101308
SWVE 15-L M18X1.5	M22X1.5 / M18X1.5	101408
SWVE 16-S R1/2	M24X1.5 / R1/2	101319
SWVE 16-S M22X1.5	M24X1.5 / M22X1.5	101419
SWVE 18-L R1/2	M26X1.5 / R3/4	25881
SWVE 18-L M22X1.5	M26X1.5 / M22X1.5	25882
SWVE 20-S R3/4	M30X2 / R3/4	101320
SWVE 22-L R3/4	M30X2 / R3/4	25856
SWVE 25-S R1/2	M36X2 / R1/2	25890
SWVE 25S R 1	M36X2 / R1	25889

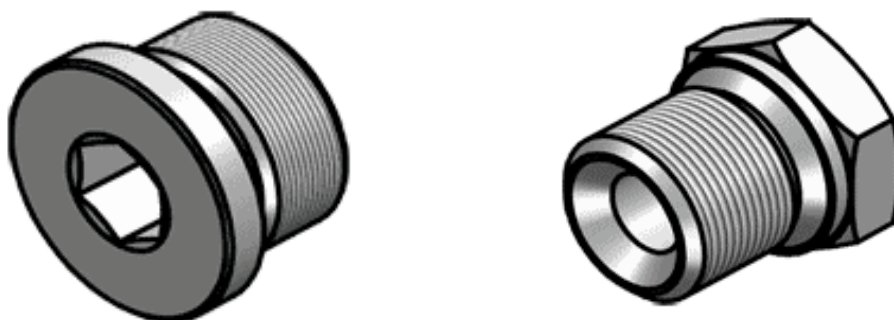
ČEP METRIČNI IN COLSKI NAVOJI

NAZIV	NAVOJ	IDENT
ČEP R1/8	R 1/8	442206
ČEP M10x1	M10X1	107701
ČEP M12x1.5	M12x1.5	27303
ČEP R1/4	R 1/4	27314
ČEP M14X1.5	M14X1.5	107703
ČEP M16X1.5 FI-8	M16X1.5 FI-8	27304
ČEP M16X1.5 FI-10	M16X1.5 FI-10	27304
ČEP R3/8	R3/8	27319
ČEP M18X1.5	M18X1.5	27334
ČEP R1/2	R 1/2	27317
ČEP M22X1.5	M 22X1.5	27318
ČEP R3/4	R 3/4	27313
ČEP M26X1.5	M26X1.5	27337
ČEP M27X2	M27X2	27335
ČEP M33X2	M33X2	27327
ČEP R1	R 1	27326
ČEP M42X2	M42X2	27328

UNF REDUCIRJI 74 STOPINJ

NAZIV	NAVOJ	IDENT
RAVNI PRIKLJ. 7/16-20	7/16-20UNF	202401
RAVNI PRIKLJ. 1/2-20	1/2-20NF	25652
RAVNI PRIKLJ. 9/16-18	9/16-18UNF	25653
RAVNI PRIKLJ. 3/4-16	3/4-16UNF	25656
RAVNI PRIKLJ. 7/8-14	7/8-14UNF	1407878
RAVNI PRIKLJ. 1 1/16-12	1 1/16-12UNF	25662
RAVNI PRIKLJ. 1 5/16	1 5/16 UNF	202407

UNF PREGRADNI PRIKLJUČKI 74 STOPINJ

NAZIV	NAVOJ	IDENT
PREG.PRIKLJ.7/16-20	7/16-20UNF	140716
PREG.PRIKLJ. 9/16-18	9/16-18UNF	202003
PREG.PRIKLJ 3/4-16	3/4-16UNF	202004
PREG.PRIKLJ 7/8-14	7/8-14UNF	202005
PREG.PRIKLJ. 1 1/16-12	1 1/16-12UNF	2020063
PREG.PRIKLJ. 1 5/16	1 5/16 UNF	2020073

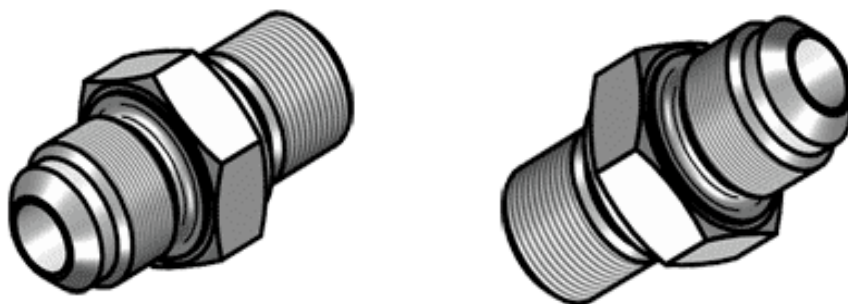
UNF NAVOJ / COLSKI NAVOJ 74 STOPINJ

NAZIV	NAVOJ	IDENT
PREG.PRIKLJ. 7/16-1/4	7/16 UNF – 1/4	205810
RAVNI PRIKLJ.9/16-1/4	9/16 UNF - 1/4	2058033
RAVNI PRIKLJ. 9/16-3/8	9/16UNF – 3/8	205816
RAVNI PRIKLJ. 9/16-1/2	9/16UNF – 1/2	205817
RAVNI PRIKLJ. 3/4-3/8	3/4UNF – 3/8	2058043
RAVNI PRIKLJ. 3/4-1/2	3/4UNF - 1/2	2058193
RAVNI PRIKLJ. 7/8-3/8	7/8UNF – 3/8	2058213
RAVNI PRIKLJ. 7/8-1/2	7/8UNF – 1/2	2058053
RAVNI PRIKLJ. 1 1/16-3/4	1 1/16UNF – 3/4	205806
RAVNI PRIKLJ.7/8-3/4	7/8UNF-3/4UNF	7834
RAVNI PRIKLJ.1 1/16-3/4	1 1/16UNF-3/4UNF	2024133

KOTNI UNF NAVOJI 74 STOPINJ

NAZIV	NAVOJ	IDENT
KOTNI PRIKLJ. 7/16	7/16 UNF	54090004
KOTNI PRIKLJ. 1/2	1/2 UNF	204002
KOTNI PRIKLJ. 9/16	9/16 UNF	54090006
KOTNI PRIKLJ. 3/4	3/4 UNF	54090008
KOTNI PRIKLJ. 7/8	7/8 UNF	54090010
KOTNI PRIKLJ. 1 1/16	1 1/16 UNF	54090012
KOTNI PRIKLJ. 1 5/16	1 5/16 UNF	54090011
KOTNI PRIKLJ. 1 5/8	1 5/8 UNF	204008

PREG.KOTNI UNF PRIKLJUČEK 74 STOPINJ

NAZIV	NAVOJ	IDENT
PREG.KOTNI 7/16	7/16 UNF	2046013
PREG.KOTNI 9/16	9/16 UNF	2046023
PREG.KOTNI 3/4	3/4 UNF	2046043
PREG.KOTNI 7/8	7/8 UNF	2046053
PREG.KOTNI 1 1/16	1 1/16 UNF	202106

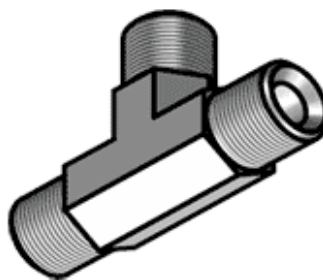
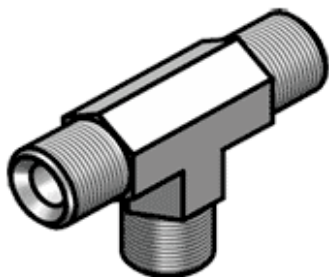
TROKRAKI PRIKLJUČEK UNF 74 STOPINJ

NAZIV	NAVOJ	IDENT
TROK. PRIKLJ 7/16	7/16 UNF	54510004
TROK. PRIKLJ 9/16	9/16 UNF	54510006
TROK. PRIKLJ. 3/4	3/4 UNF	54510008
TROK. PRIKLJ 7/8	7/8 UNF	54510010

RAVNI PRIKLJ M + Ž NAVOJ M-COLSKI NAVOJ, Ž – UNF NAVOJ

NAZIV	NAVOJ	IDENT
M+Ž 1/4 – 7/16	1/4 – 7/16 UNF	203510
M+Ž 1/4 – 9/16	1/4 – 9/16 UNF	203503
M+Ž 3/8 – 9/16	3/8 – 9/16 UNF	203514
M+Ž 3/8 - 3/4	3/8 – 3/4 UNF	203504
M+Ž 3/8 – 7/8	3/8 – 7/8 UNF	203518
M+Ž 1/2 – 3/4	1/2 – 3/4 UNF	203517
M+Ž 1/2 – 7/8	1/2 – 7/8 UNF	203506
M+Ž 3/4 – 1 1/16	3/4 – 1 1/16 UNF	203506
M+Ž 1 – 1 5/16	1 – 1 5/16 UNF	203507

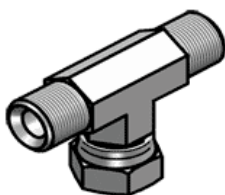
TROKRAKI PRIKLJUČEK Z ZUNANJIM NAVOJEM UNF IS KOTOM 74 stopinj

M-F-M - MATICA NA SREDINI-- T-KOS-a

M-M-F – MATICA NA ENI STRANI T-KOS-a

NAZIV	NAVOJ	IDENT
7/16 UNF M-M-F	7/16 UNF	54590004
9/16 UNF M-M-F	9/16 UNF	54590006
9/16 UNF M-F-M	9/16 UNF	204303
3/4 UNF M-M-F	3/4 UNF	54590008
3/4 UNF M-F-M	3/4 UNF	54550008
7/8 UNF M-M-F	7/8 UNF	54590010
7/8 UNF M-F-M	7/8 UNF	54550010
1 1/16 UNF M-M-F	1 1/16 UNF	5455008
1 1/16 UNF M-F-M	1 1/16 UNF	5455007

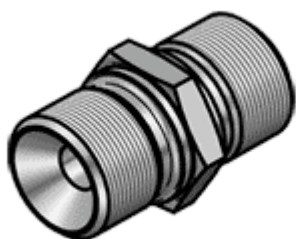
RAVNI PRIKLUČKI UN

NAZIV	NAVOJ	IDENT
RAVNI PRIKLJ. 9/16-18 UN	9/16X18UN	401701
RAVNI PRIKLJ. 11/16X16UN	11/16X16UN	401702
RAVNI PRIKLJ. 13/16X16UN	13/16X16UN	401703
RAVNI PRIKLJ. 1X14UN	1X14UN	401704
RAVNI PRIKLJ. 1 3/16X12UN	1 3/16X12UN	401705
9/16UN – 11/16UN	9/16X18UN,11/16X16UN	401709
13/16UN – 11/16UN	13/16X16UN,11/16X16UN	401711

PREG.PRIKLJ. UN

NAZIV	NAVOJ	IDENT
PREG.PRIKLJ. 9/16UN	9/16X18UN	401801
PREG.PRIKLJ. 11/16UN	11/16X16UN	401802
PREG.PRIKLJ. 13/16UN	13/16X16UN	401803
PREG.PRIKLJ. 1UN	1-14UN	401804
PREG.PRIKLJ.1 3/16UN	1 3/16X12UN	401805
PREG.PRIKLJ. 1 7/16UN	1 7/16X12UN	401806

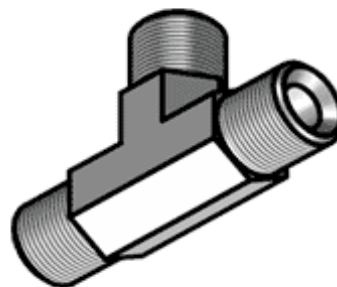
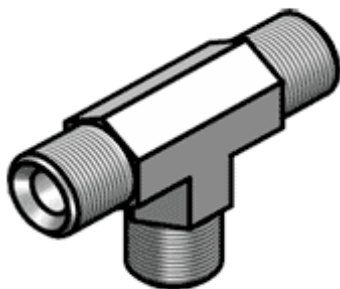
TROKRAKI PRIKLUČEK UN

NAZIV	NAVOJ	IDENT
TROK.PRIKLJ 9/16 UN	9/16X18UN	404901
TROK.PRIKLJ. 11/16UN	11/16X16UN	404902
TROK.PRIKLJ. 13/16UN	13/16X16UN	404903
TROK.PRIKLJ. 1UN	1X14UN	404904
TROK.PRIKLJ.1 13/16UN	1 13/16X12UN	404905

NAST.KOTNI UNF/ COLSKI NAVOJ

NAZIV	NAVOJ	IDENT
PREG.KOTNI 7/16UNF, R1/4	7/16UNF, R1/4	204410
PREG.KOTNI 9/16UNF, R1/4	9/16UNF, R1/4	2044033
PREG.KOTNI 9/16UNF, R3/8	9/16UNF, R3/8	204415
PREG.KOTNI 3/4UNF, R3/8	3/4UNF, R3/8	204404
PREG.KOTNI 3/4UNF, R1/2	3/4UNF, R1/2	204418
PREG.KOTNI 7/8UNF, R1/2	7/8UNF, R1/2	204405
PREG.KOTNI 7/8UN, R3/8	7/8UNF, R3/8	204420

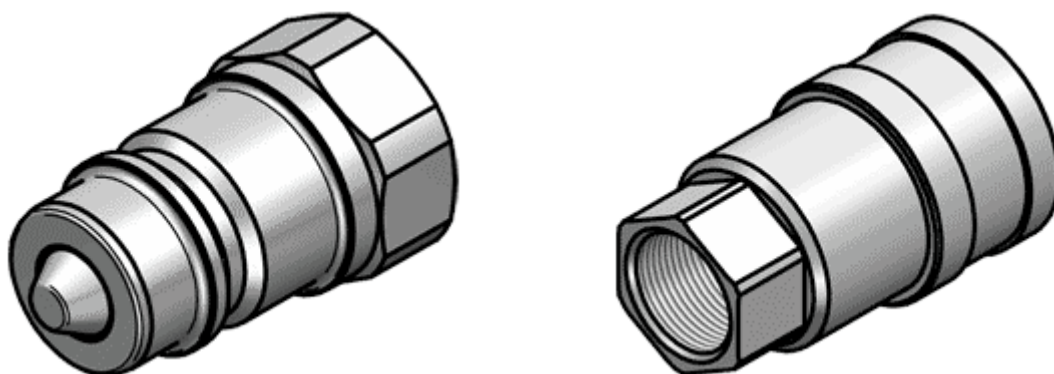
HITRE SPOJKE KLASIČNE

NAZIV	NAVOJ	MOŠKA	ŽENSKA
PAV1 DN-06 G1/4	G1/4	101001	101000
PAV1 DN-10 G3/8	G3/8	101003	101002
PAV1 DN-13 G1/2	G1/2	13130031	13130021
PAV1 DN-13 M22X1.5	M22X1.5	1322103	1322102
PAV1 DN-20 G3/4	G3/4	2019113	2019112
PAV1 DN-25 G1	G1	2525003	2525002
PAV1 DN 1 1/4	G 1 1/4	3031003	3031002
PAV1 DN 1 1/2	G 1 1/2	3939003	3939002
PAV1 DN 2	G 2	5051003	5051002

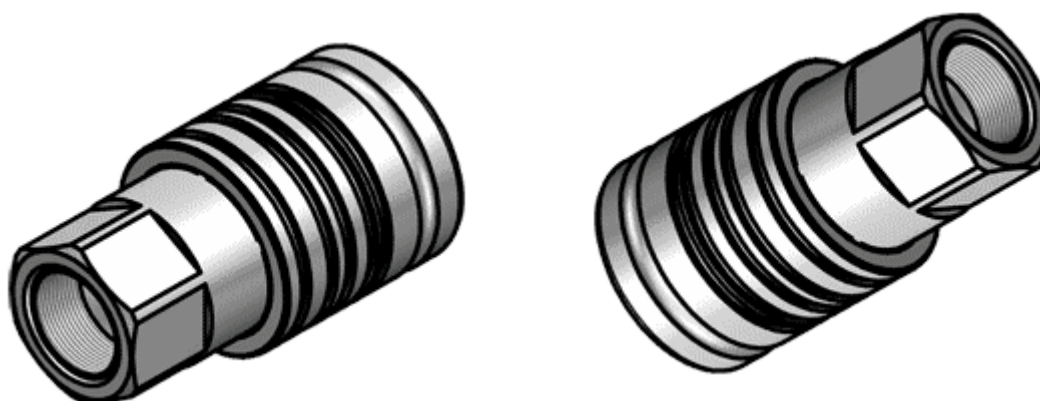
HITRE SPOJKE KLASIČNE ŽENSKE PUSH PULL

NAZIV	NAVOJ	IDENT
PAV1 DN-13 G1/2 PUSH PULL	G 1/2	1324102
PAV1 DN-13 M22X1.5 PUSH PULL	M22X1.5	1323102

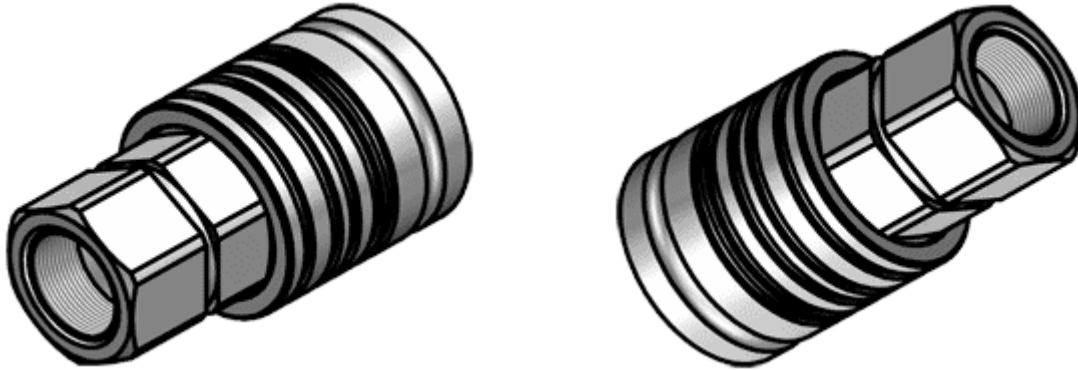
HITRA SPOJKA ŽENSKA PUSH PULL VES MEHANIZEM V SPOJKI (FAST TRACK SISTEM)

NAZIV	NAVO	IDENT
PKK4 DN-13 G1/2	G 1/2	41313112

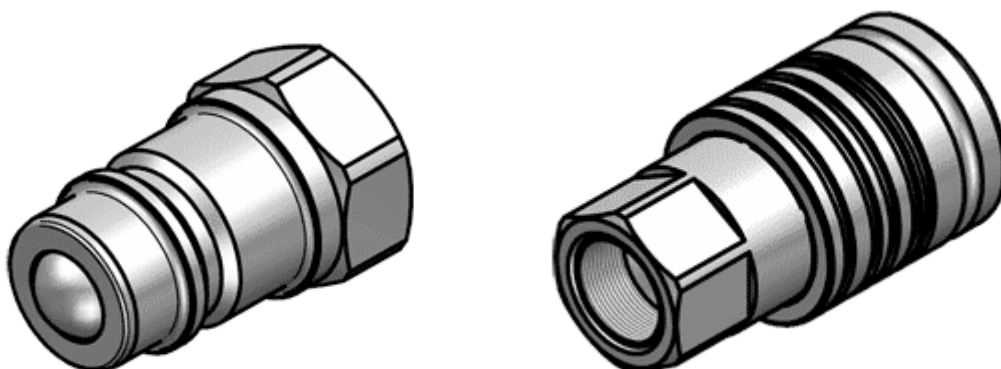
HITRA SPOJKA PAV NA KROGLO

NAZIV	NAVOJ	MO-ŠKA	ŽENSKA
HITRA SPOJKA Z KROGLO G1/2	G1/2	13130032	13130022

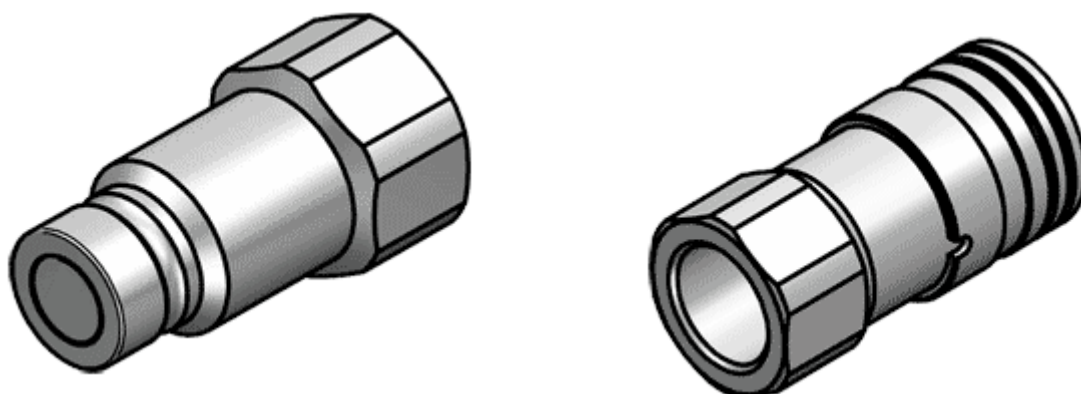
HITRE SPOJKE RAVNA POVRŠINA PLT4 VIŠJI PRITISK

NAZIV	NAVOJ	MOŠKA	ŽENSKA
PLT4 DN-04 G1/8	G1/8	404113	404112
PLT4 DN-06 G1/4	G1/4	606113	606112
PLT4 DN-06 G3/8	G3/8	1310106	1310105
PLT4 DN-13 G1/2	G1/2	1313113	1313112
PLT4 DN-20 G3/4	G3/4	2019113	2019112
PLT4 DN-22 G3/4	G3/4	2219113	2219112
PLT4 DN-25 G1	G1	2525113	2525112
PLT4 DN-30 G 1 1/4	G1 1/4	3031113	3031112

HITRE SPOJKA NA NAVOJ

MOŠKA		ŽENSKA	
DN-10 G1/4	1006113	DN-10 G1/4	1006112
DN-13 G3/8	1310113	DN-13 G3/8	1310112
DN-13 M22X1.5	13221031	DN-13 M22X1.5	13221021
DN-20 G3/4	2020113	DN-20 G3/4	2020112
DN-25 G1	2526113	DN-25 G1	2526112

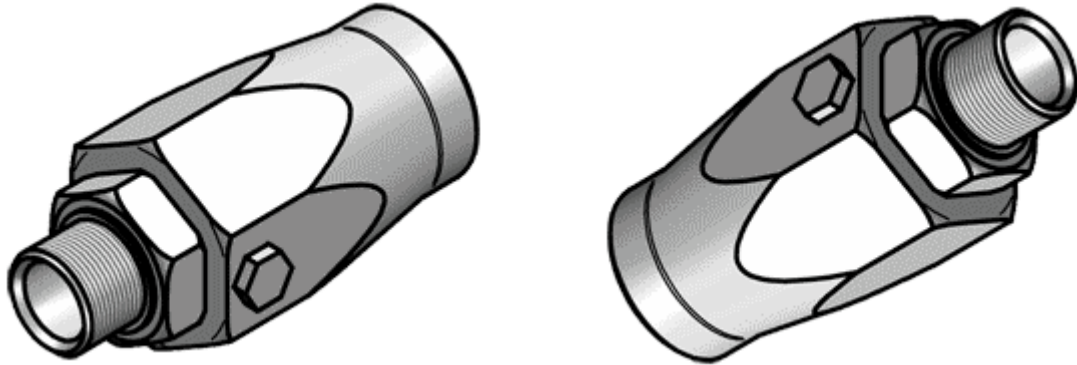
VRTLJIVI PRIKLJUČEK (VLEŽAJENI DEL)

NAZIV	IDENT:
VENTIL VRTLJIVI 1/4	21950
VENTIL VRTLJIVI 3/8	21925
VENTIL VRTLJIVI 1/2	21951
VENTIL VRTLJIVI 3/4	21952
VENTIL VRTLJIVI 1«	21953

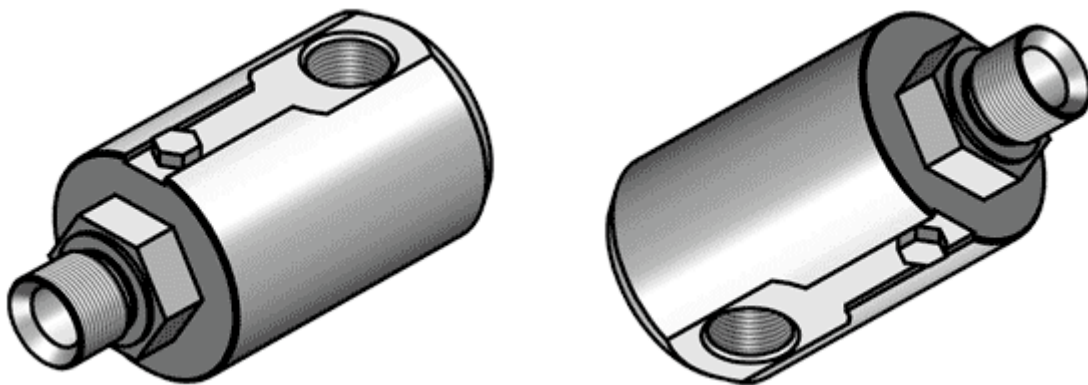
VRTLJIVI VENTIL / 90 (VLEŽAJEN DEL)

NAZIV	IDENT:
VENTIL VRTLJIVI /90 3/4	21952