

HIDRO 

ZAVRH- *proizvodnja*
servis hidravlike

PROIZVODNJA

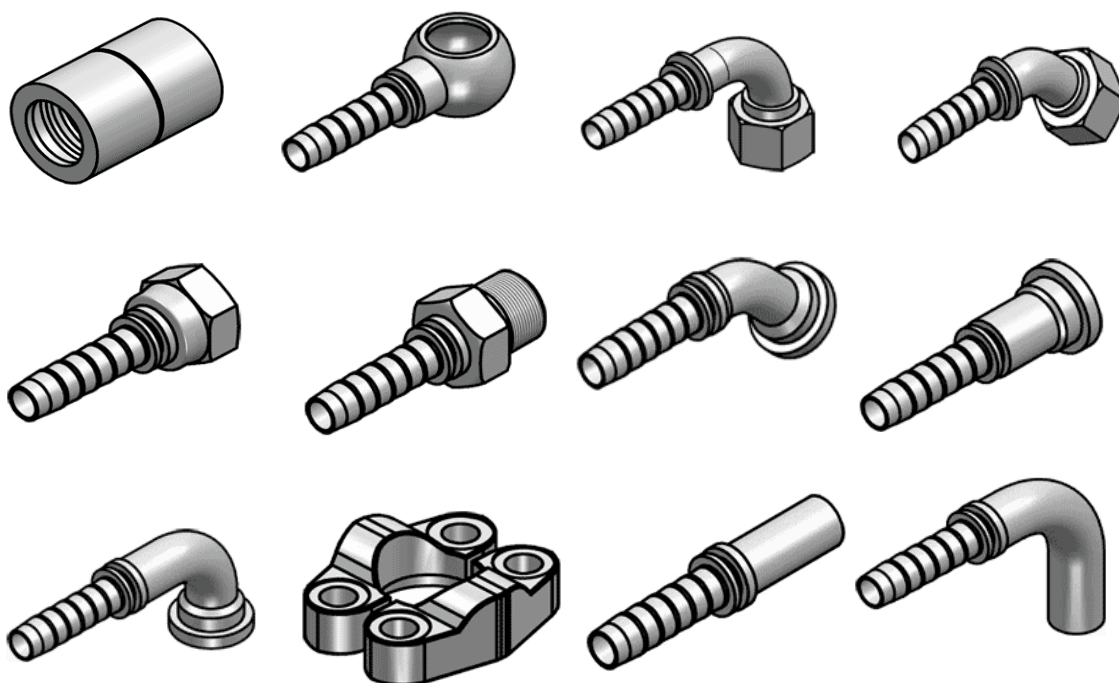

KATALOG PRIKLJUČKOV

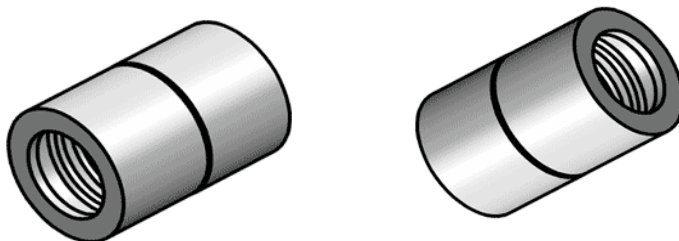
PUŠA V1

NAZIV	IDENT
PUŠA V1 DN - 5	2310619
PUŠA V1 DN - 6 WAP	2310618
PUŠA V1 DN - 6	2310620
PUŠA V1 DN - 8	2310820
PUŠA V1 DN - 10	2311024
PUŠA V1 DN - 12	2311226
PUŠA V1 DN - 16	2311630
PUŠA V1 DN - 19	2311935
PUŠA V1 DN - 25	2312545
PUŠA V1 DN - 32	2313250
PUŠA V1 DN - 40	2314060
PUŠA V1 DN - 50	2315070

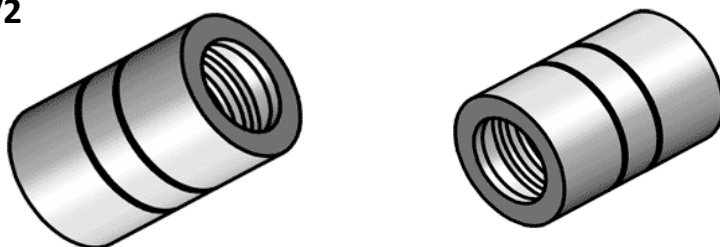
PUŠA V2

NAZIV	IDENT
PUŠA V2 DN - 6	2320620
PUŠA V2 DN - 8	2320822
PUŠA V2 DN - 10	2321025
PUŠA V2 DN - 12	2321228
PUŠA V2 DN - 16	2321632
PUŠA V2 DN - 19	2321938
PUŠA V2 DN - 25	2322545
PUŠA V2 DN - 32	2323255
PUŠA V2 DN - 40	2324065
PUŠA V2 DN - 50	2325075

PUŠA V4



NAZIV	IDENT
PUŠA V4 DN - 6	2340624
PUŠA V4 DN - 10	2341028
PUŠA V4 DN - 12	2341230
PUŠA V4 DN - 16	2341635
PUŠA V4 DN - 19	2341940
PUŠA V4 DN - 25	2342548
PUŠA V4 DN - 32	2343260
PUŠA V4 DN - 40	2344067
PUŠA V4 DN - 50	2345080

PUŠA TEFLON



NAZIV	IDENT
PUŠA TEFLON DN-6	2311022
PUŠA TEFLON DN-8	2311023
PUŠA TEFLON DN-10	2311026
PUŠA TEFLON DN-12	2311025

PUŠA GŽ NIZKI TLAK

NAZIV	IDENT
PUŠA GŽ DN-6	23106
PUŠA GŽ DN-8	23108
PUŠA GŽ DN-10	23110
PUŠA GŽ DN-12	23112

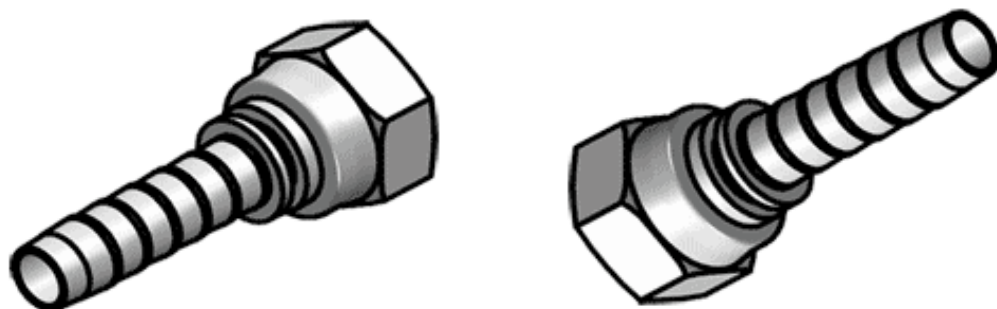
A1 PRIKLJUČKI

NAZIV	KONUS	IDENT
A1 M12x1.5 DN-6	fi -6	15126
A1 M14x1.5 DN-6	fi - 8	15146
A1 M16X1.5 DN-6	fi - 10	15146
A1 M18X1.5 DN-6	fi -12	15186
A1 M14X1.5 DN-8	fi - 8	15148
A1 M16X1.5 DN-8	fi - 10	15168
A1 M18X1.5 DN-8	fi - 12	15188
A2 M20X1.5 DN-8	fi - 12	15208
A1 M22X1.5 DN-8	fi - 15	15228
A1 M18X1.5 DN-10	fi - 12	151810
A2 M20X1.5 DN-10	fi -12	152010
A1 M22X1.5 DN-10	fi -14	202210
A1 M24X1.5 DN-10	fi - 16	202410
A2 M20X1.5 DN-12	fi - 12	202012
A1 M22x1.5 DN -12	fi - 15	152212
A2 M24x1.5 DN - 12	fi - 16	202412
A1 M26X1.5 DN - 12	fi - 18	152612
A1 M26x1.5 DN - 16	fi - 18	152616
A2 M30x2 DN - 16	fi - 20	203016
A2 M26x1.5 DN - 19	fi - 18	202619
A1 M30x2 DN-19	fi - 22	153019
A2 M36x2 DN - 19	fi - 25	203619
A2 M42x2 DN - 25	fi - 30	204225
A1 M45x2 DN - 32	fi - 35	204532
A2 M52x2 DN - 32	fi - 38	205232

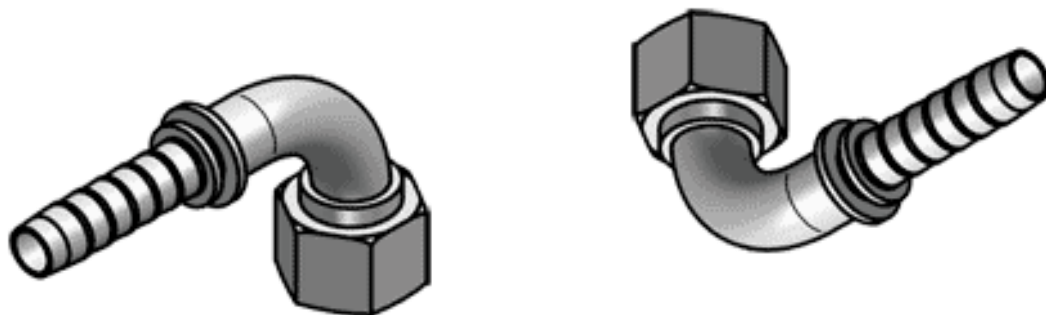
A1/90 PRIKLJUČKI

NAZIV	KONUS	IDENT
A1/90 M10X1 DN-6	fi - 6	11106
A1/90 M12X1.5 DN-6	fi - 6	16126
A1/90 M14X1.5 DN-6	fi - 8	16146
A1/90 M14X1.5 DN-8	fi - 8	16148
A1/90 M16X1.5 DN-8	fi - 10	16168
A1/90 M18X1.5 DN-8	fi - 12	16188
A2/90 M20X1.5 DN - 8	fi - 12	21208
A1/90 M18X1.5 DN-10	fi - 12	161810
A2/90 M20X1.5 DN-10	fi - 12	212010
A2/90 M22X1.5 DN-10	fi - 14	212210
A2/90 M20X1.5 DN-12	fi - 12	212012
A1/90 M22X1.5 DN-12	fi - 15	162212
A2/90 M24X1.5 DN-12	fi - 16	212412
A1/90 M26X1.5 DN-16	fi - 18	162616
A2/90 M30X2 DN-16	fi - 20	213016
A2/90 M26X1.5 DN-19	fi - 18	212619
A1/90 M30X2 DN-19	fi - 22	163019
A2/90 M36X2 DN-19	fi - 25	213619
A2/90 M42X2 DN-25	fi - 30	214225
A1/90 M45X2 DN-32	fi - 35	214532
A2/90 M52X2 DN-32	fi - 38	215232

A1/45 PRIKLJUČKI



NAZIV	KONUS	IDENT
A1/45 M10X1 DN-6	fi - 6	12106
A1/45 M12X1.5 DN-6	fi - 6	17126
A1/45 M14X1.5 DN-6	fi - 8	17146
A1/45 M14X1.5 DN-8	fi - 8	17148
A1/45 M16X1.5 DN-8	fi - 10	17168
A1/45 M18X1.5 DN-8	fi - 12	17188
A2/45 M20X1.5 DN - 8	fi - 12	22208
A1/45 M18X1.5 DN-10	fi - 12	171810
A2/45 M20X1.5 DN-10	fi - 12	222010
A2/45 M22X1.5 DN-10	fi - 14	222210
A2/45 M20X1.5 DN-12	fi - 12	222012
A1/45 M22X1.5 DN-12	fi - 15	172212
A2/45 M24X1.5 DN-12	fi - 16	222412
A1/45 M26X1.5 DN-16	fi - 18	172616
A2/45 M30X2 DN-16	fi - 20	223016
A2/45 M26X1.5 DN-19	fi - 18	222619
A1/45 M30X2 DN-19	fi - 22	173019
A2/45 M36X2 DN-19	fi - 25	223619
A2/45 M42X2 DN-25	fi - 30	224225
A1/45 M45X2 DN-32	fi - 35	224532
A2/45 M52X2 DN-32	fi - 38	225232

M2 PRIKLJUČKI

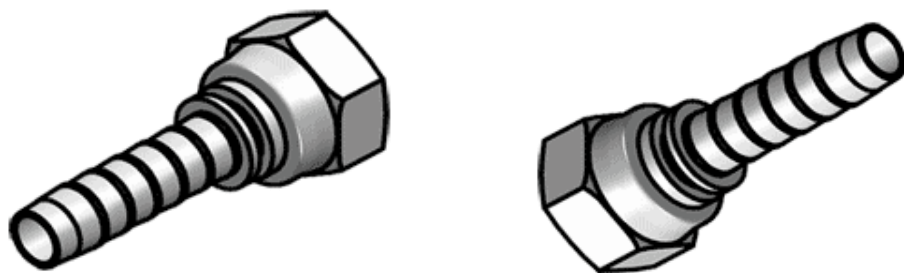

NAZIV	KONUS	IDENT
M2 M12X1.5 DN-5	fi - 6	80125
M2 M12X1.5 DN-6	fi - 6	80126
M2 M14X1.5 DN-6	fi - 8	80146
M2 M16X1.5 DN-6	fi - 8	80166
M2 M16X1.5 DN-6	fi - 10	801606
M2 M16x1.5 DN-8	fi - 10	80168
M2 M18X1.5 DN-8	fi - 12	80188
M2 M20X1.5 DN-8	fi - 12	80208
M2 M16X1.5 DN-10	fi - 10	801610
M2 M18X1.5 DN-10	fi - 12	801810
M2 M20X1.5 DN-10	fi - 12	802010
M2 M22X1.5 DN-10	fi - 15	802210
M2 M22X1.5 DN-12	fi - 15	802212
M2 M24X1.5 DN-12	fi - 16	802412
M2 M26X1.5 DN-16	fi - 18	802616
M2 M22X1.5 DN-16	fi - 15	802216
M2 M24X1.5 DN-16	fi - 16	802416
M2 M30X2 DN - 16	fi - 20	803016
M2 M30X2 DN-19	fi - 22	803019
M2 M36X2 DN-19	fi - 25	803619
M2 M42X2 DN-19	fi - 30	804219
M2 M36X2 DN-25	fi - 28	803625
M2 M42X2 DN-25	fi - 30	804225
M2 M42X2 DN-32	fi - 30	804232
M2 M45X2 DN-32	fi - 35	804532
M2 M52X2 DN-32	fi - 38	805232
M2 M52X2 DN-40	fi - 42	805240

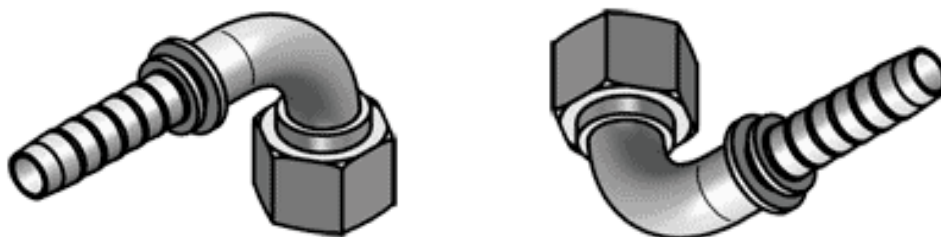
M2/90 PRIKLJUČKI

NAZIV	KONUS	IDENT
M2/90 M12X1.5 DN-5	fi - 6	81125
M2/90 M12X1.5 DN-6	fi - 6	81126
M2/90 M14X1.5 DN-6	fi - 8	81146
M2/90 M16X1.5 DN-6	fi - 8	81166
M2/90 M16X1.5 DN-6	fi - 10	811606
M2/90 M16x1.5 DN-8	fi - 10	81168
M2/90 M18X1.5 DN-8	fi - 12	81188
M2/90 M20X1.5 DN-8	fi - 12	81208
M2/90 M16X1.5 DN-10	fi - 10	811610
M2/90 M18X1.5 DN-10	fi - 12	811810
M2/90 M20X1.5 DN-10	fi - 12	812010
M2/90 M22X1.5 DN-10	fi - 15	812210
M2/90 M22X1.5 DN-12	fi - 15	812212
M2/90 M24X1.5 DN-12	fi - 16	812412
M2/90 M26X1.5 DN-16	fi - 18	812616
M2/90 M30X2 DN - 16	fi - 20	813016
M2/90 M30X2 DN-19	fi - 22	813019
M2/90 M36X2 DN-19	fi - 25	813619
M2/90 M42X2 DN-19	fi - 30	814219
M2/90 M36X2 DN-25	fi - 28	813625
M2/90 M42X2 DN-25	fi - 30	814225
M2/90 M42X2 DN-32	fi - 30	814232
M2/90 M45X2 DN-32	fi - 35	814532
M2/90 M52X2 DN-32	fi - 38	815232
M2/90 M52X2 DN-40	fi - 42	815240

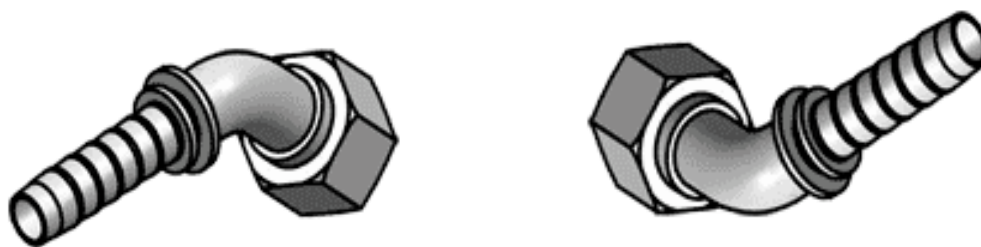
M2/45 PRIKLJUČKI

NAZIV	KONUS	IDENT
M2/45 M12X1.5 DN-5	fi - 6	82125
M2/45 M12X1.5 DN-6	fi - 6	82126
M2/45 M14X1.5 DN-6	fi - 8	82146
M2/45 M16X1.5 DN-6	fi - 8	82166
M2/45 M16X1.5 DN-6	fi - 10	821606
M2/45 M16x1.5 DN-8	fi - 10	82168
M2/45 M18X1.5 DN-8	fi - 12	82188
M2/45 M20X1.5 DN-8	fi - 12	82208
M2/45 M16X1.5 DN-10	fi - 10	821610
M2/45 M18X1.5 DN-10	fi - 12	821810
M2/45 M20X1.5 DN-10	fi - 12	822010
M2/45 M22X1.5 DN-10	fi - 15	822210
M2/45 M22X1.5 DN-12	fi - 15	822212
M2/45 M24X1.5 DN-12	fi - 16	822412
M2/45 M26X1.5 DN-16	fi - 18	822616
M2/45 M30X2 DN - 16	fi - 20	823016
M2/45 M30X2 DN-19	fi - 22	823019
M2/45 M36X2 DN-19	fi - 25	823619
M2/45 M42X2 DN-19	fi - 30	824219
M2/45 M36X2 DN-25	fi - 28	823625
M2/45 M42X2 DN-25	fi - 30	824225
M2/45 M42X2 DN-32	fi - 30	824232
M2/45 M45X2 DN-32	fi - 35	824532
M2/45 M52X2 DN-32	fi - 38	825232
M2/45 M52X2 DN-40	fi - 42	825240

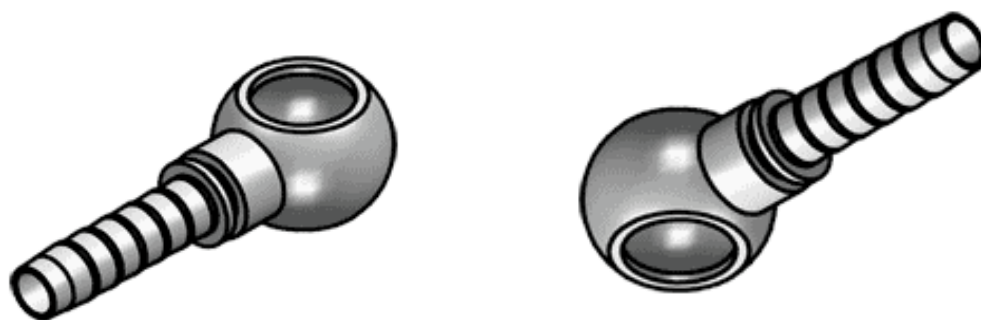
OČESNI PRIKLJUČEK B

NAZIV	IDENT	NAZIV	IDENT
B Ø10 DN-5	40105	B 1/2 DN-10	402110
B Ø12 DN-5	40125	B Ø22 DN-10	402210
B Ø14 DN-5	40145	B 3/4 DN-10	403410
B Ø10 DN-6	40106	B Ø16 DN-12	401612
B Ø12 DN-6	40126	B 3/8 DN-12	401712
B 1/4 DN-6	40136	B Ø18 DN-12	401812
B Ø14 DN-6	40146	B 1/2 DN-12	402112
B Ø16 DN-6	40166	B Ø22 DN-12	402212
B 3/8 DN-6	40176	B 3/4 DN-12	403412
B Ø12DN-8	40128	B Ø22 DN-16	402216
B 1/4 DN-8	40138	B 3/4 DN-16	403416
B Ø14 DN-8	40148	B 3/4 DN-19	403419
B Ø16 DN-8	40168	B 1 DN-25	401025
B 3/8 DN-8	40178		
B Ø18 DN-8	40188		
B Ø14 DN-10	401410	B Ø8 DN-6 GŽ	40086
B Ø16 DN-10	401610	B Ø10 DN-6 GŽ	40106
B 3/8 DN-10	401710	B Ø12 DN-6 GŽ	40126
B Ø18 DN-10	401810	B Ø12 DN-8 GŽ	40128
B Ø20 DN-10	402010	B Ø14 DN-8 GŽ	40148

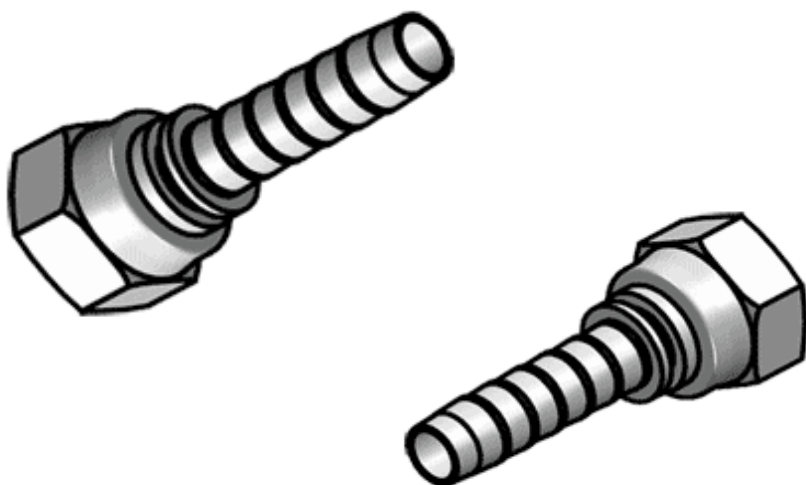
Ar PRIKLJUČKI

NAZIV	IDENT
Ar 1/4 DN-6	30145
Ar 1/4 DN-6	30146
Ar 1/4 DN-8	30148
Ar 3/8 DN-8	30388
Ar 3/8 DN-10	303810
Ar 1/2 DN-10	301210
Ar 1/2 DN-12	301212
Ar 3/4 DN-12	303412
Ar 5/8 DN-16	305816
Ar 3/4 DN-16	303416
Ar 3/4 DN-19	303419
Ar 3/4 V4 DN-19	303519
Ar 1 V4 DN-19	301019
Ar 1 V4 DN-25	301025
Ar 1 V2 DN-25	301025V2
Ar 5/4 V2 DN-32	305432V2
Ar 5/4 V4 DN-32	305432
Ar 6/4 DN-32	306432
Ar 6/4 DN-40	306440
Ar 2 DN-50	302050

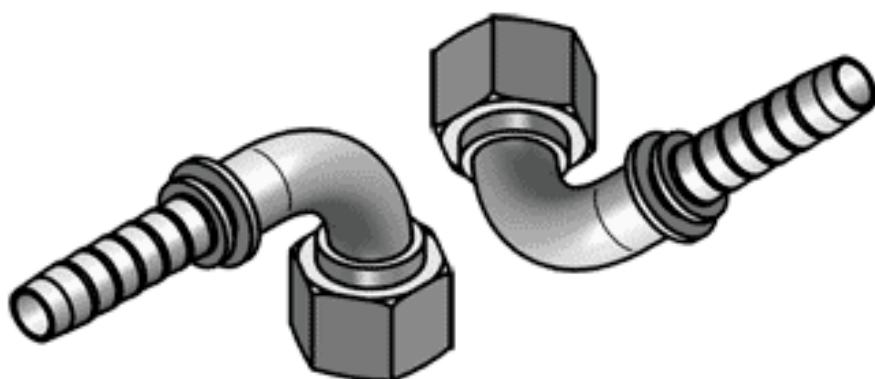
Ar /90 PRIKLJUČKI

NAZIV	IDENT
Ar/90 1/4 DN-6	31146
Ar/90 1/4 DN-8	31148
Ar/90 3/8 DN-8	31388
Ar/90 3/8 DN-10	313810
Ar/90 1/2 DN-10	311210
Ar/90 1/2 DN-12	311212
Ar/90 3/4 DN-12	313412
Ar/90 5/8 DN-16	315816
Ar/90 3/4 DN-16	313416
Ar/90 3/4 DN-19	313419
Ar/90 3/4 V4 DN-19	313519
Ar/90 1 V4 DN-19	311019
Ar/90 1 V4 DN-25	311025
Ar/90 1 V2 DN-25	311025V2
Ar/90 5/4 V2 DN-32	315432V2
Ar/90 5/4 V4 DN-32	315432
Ar/90 6/4 DN-32	316432
Ar/90 6/4 DN-40	316440
Ar/90 2 DN-50	312050

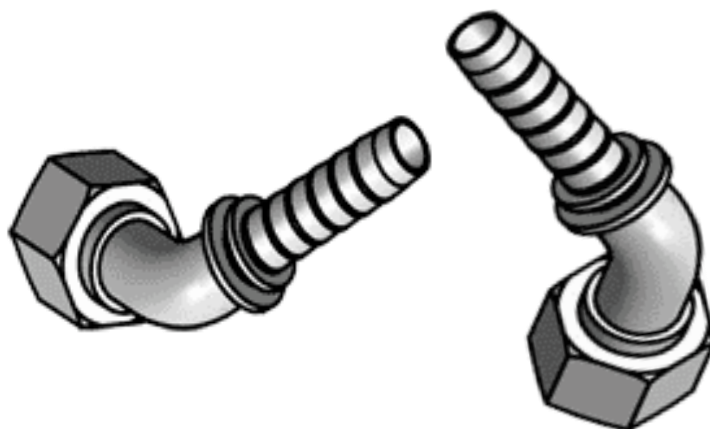
Ar / 45 PRIKLJUČKI

NAZIV	IDENT
Ar/45 1/4 DN-6	32146
Ar/45 1/4 DN-8	32148
Ar/45 3/8 DN-8	32388
Ar/45 3/8 DN-10	323810
Ar/45 1/2 DN-10	321210
Ar/45 1/2 DN-12	321212
Ar/45 3/4 DN-12	323412
Ar/45 5/8 DN-16	325816
Ar/45 3/4 DN-16	323416
Ar/45 3/4 DN-19	323419
Ar/45 3/4 V4 DN-19	323519
Ar/45 1 V4 DN-19	321019
Ar/45 1 V4 DN-25	321025
Ar/45 1 V2 DN-25	321025V2
Ar/45 5/4 V2 DN-32	325432V2
Ar/45 5/4 V4 DN-32	325432
Ar/45 6/4 DN-32	326432
Ar/45 6/4 DN-40	326440
Ar/45 2 DN-50	322050

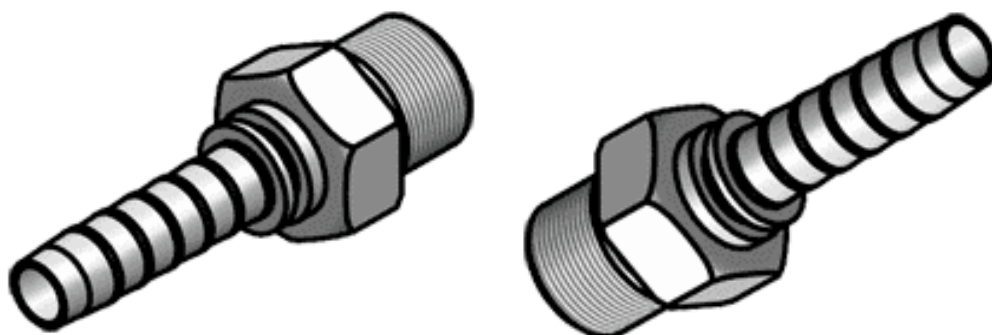
J PRIKLJUČKI

NAZIV	KONUS	IDENT
J1 M12X1.5 DN-6	fi - 6	110126
J1 M14X1.5 DN-6	fi - 8	110146
J2 M18X1.5 DN-6	fi - 10	120186
J1 M14X1.5 DN-8	fi - 8	110148
J1 M16X1.5 DN-8	fi - 10	110168
J2 M18X1.5 DN-8	fi - 10	120188
J2 M20X1.5 DN-8	fi - 12	120208
J1 M16X1.5 DN-10	fi - 10	110168
J1 M18X1.5 DN-10	fi - 12	1101810
J1 M20X1.5 DN-10	fi - 12	1202010
J2 M22X1.5 DN-10	fi - 14	1202210
J1 M22X1.5 DN-12	fi - 15	1102212
J2 M24X1.5 DN-12	fi - 16	1202412
J1 M26X1.5 DN-16	fi - 18	1102616
J2 M30X2 DN-16	fi - 20	1203016
J2 M30X2 DN-19	fi - 22	1203019
J2 M36X2 DN-19	fi - 25	1203619
J2 M42X2 DN-25	fi - 30	1204225
J1 M45X2 DN-32	fi - 35	1104532
J2 M52X2 DN-32	fi - 38	1205232
J2 M52X2 DN-4	fi - 42	1205240

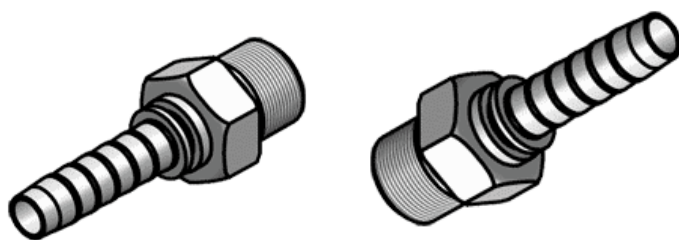
G PRIKLJUČKI

NAZIV	IDENT
G M10X1 DN-6	130106
G M22X1.5 DN-6	130226
G M22X1.5 DN-8	130228
G M22X1.5 DN-10	1302210
G M22X1.5 DN-12	1302212

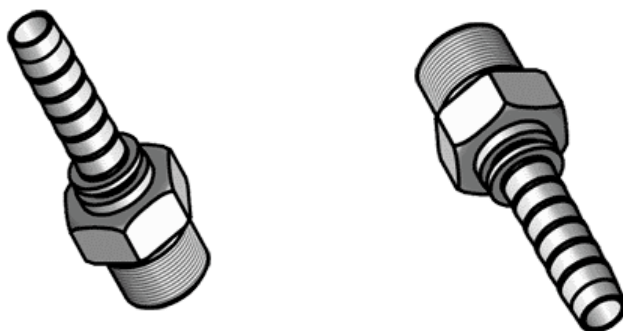
GR PRIKLJUČKI

NAZIV	IDENT
Gr 1/4 DN-6	140146
Gr 1/4 DN-8	140148
Gr 3/8 DN-8	140388
Gr 1/2 DN-8	140128
Gr 3/8 DN-10	1403810
Gr 1/2 DN-10	1401210
Gr 1/2 DN-12	1401212
Gr 5/8 DN-16	1405816
Gr 3/4 DN-16	1403416
Gr 3/4 DN-19	1403419
Gr 1 DN-19	1401019
Gr 1 DN-25	1401025
Gr 5/4 DN-25	1405425
Gr 5/4 DN-32	1405432
Gr 6/4 DN-40	1406440
Gr 2 DN-50	1402050

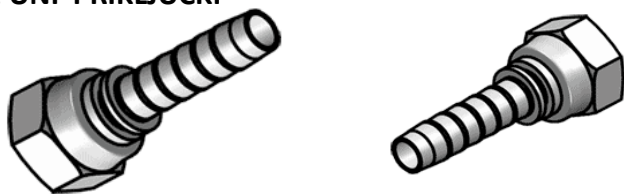
D1 UNF PRIKLUČKI

NAZIV	IDENT
D1 7/16 DN-6	507166
D1 1/2 DN-6	50126
D1 1/2 DN-8	50128
D1 9/16 DN-8	509168
D1 9/16 DN-10	5091610
D1 3/4 DN-10	503410
D1 7/8 DN-10	507810
D1 3/4 DN-12	503412
D1 7/8 DN-12	507812
D1 1 1/16 DN-12	50111612
D1 7/8 DN-16	507816
D1 1 1/16 DN-16	50111616
D1 1 1/16 DN-19	50111619
D1 1 5/16 DN-19	50151619
D1 1 5/16 DN-25	50151625
D1 1 5/8 DN-32	5015832

K1 PRIKLUČKI UNF

NAZIV	IDENT
K1 7/16 DN-6	1507166
K1 1/2 DN-6	150126
K1 1/2 DN-8	150128
K1 9/16 DN-8	1509168
K1 9/16 DN-10	15091610
K1 3/4 DN-10	1503410
K1 7/8 DN-10	1507810
K1 3/4 DN-12	1503412
K1 7/8 DN-12	1507812
K1 1 1/16 DN-12	150111612
K1 7/8 DN-16	1507816
K1 1 1/16 DN-16	150111616
K1 1 1/16 DN-19	150111619
K1 1 5/16 DN-19	150151619
K1 1 5/16 DN-25	150151625
K1 1 5/8 DN-32	15015832

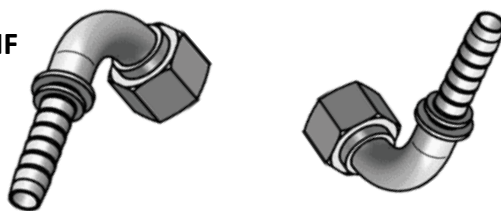
D1/90 PRIKLJUČKI UNF

NAZIV	IDENT
D1/90 7/16 DN-6	517166
D1/90 1/2 DN-6	51126
D1/90 1/2 DN-8	51128
D1/90 9/16 DN-8	519168
D1/90 9/16 DN-10	5191610
D1/90 3/4 DN-10	513410
D1/90 7/8 DN-10	517810
D1/90 3/4 DN-12	513412
D1/90 7/8 DN-12	517812
D1/90 1 1/16 DN-12	5111612
D1/90 7/8 DN-16	517816
D1/90 1 1/16 DN-16	5111616
D1/90 1 1/16 DN-19	5111619
D1/90 1 5/16 DN-19	51151619
D1/90 1 5/16 DN-25	51151625
D1/90 1 5/8 DN-32	5115832

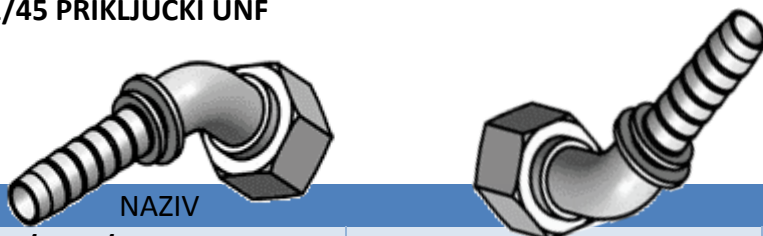
D1/45 PRIKLJUČKI UNF

NAZIV	IDENT
D1/45 7/16 DN-6	527166
D1/45 1/2 DN-6	52126
D1/45 1/2 DN-8	52128
D1/45 9/16 DN-8	529168
D1/45 9/16 DN-10	5291610
D1/45 3/4 DN-10	523410
D1/45 7/8 DN-10	527810
D1/45 3/4 DN-12	523412
D1/45 7/8 DN-12	527812
D1/45 1 1/16 DN-12	5211612
D1/45 7/8 DN-16	527816
D1/45 1 1/16 DN-16	5211616
D1/45 1 1/16 DN-19	5211619
D1/45 1 5/16 DN-19	52151619
D1/45 1 5/16 DN-25	52151625
D1/45 1 5/8 DN-32	5215832

UN PRIKLJUČKI (CAT)

NAZIV	IDENT
C 9/16 DN-6	991611606
C 11/16 DN-10	911161610
C 13/16 DN-10	913161610
C 13/16 DN-12	913161612
C 1 DN-16	910141616
C 1 13/16 DN-19	913161619
C 1 7/16 DN-25	917161625

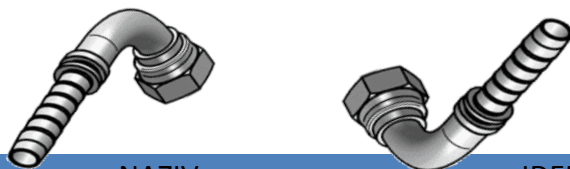
UN / 90 PRIKLJUČKI (CAT)

NAZIV	IDENT
C/90 9/16 DN-6	991611706
C/90 11/16 DN-10	911161710
C/90 13/16 DN-10	913161710
C/90 13/16 DN-12	913161712
C/90 1 DN-16	910141716
C/90 1 13/16 DN-19	913161719
C/90 1 7/16 DN-25	917161725

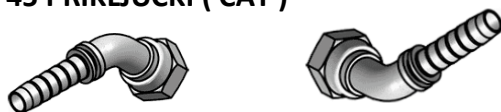
UN / 45 PRIKLJUČKI (CAT)

NAZIV	IDENT
C/45 9/16 DN-6	991611806
C/45 11/16 DN-10	911161810
C/45 13/16 DN-10	913161810
C/45 13/16 DN-12	913161812
C/45 1 DN-16	910141816
C/45 1 13/16 DN-19	913161819
C/45 1 7/16 DN-25	917161825

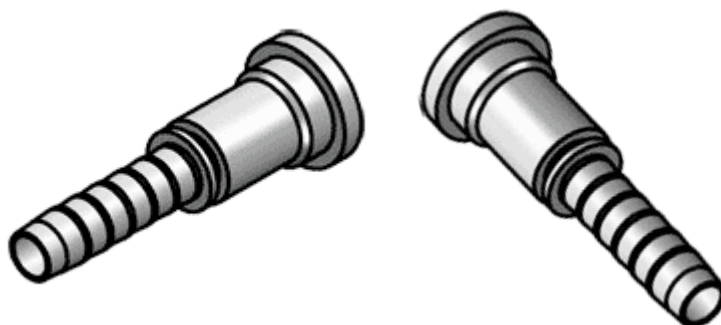
P PRIKLJUČKI

NAZIV	IDENT
P1 d=30,2 DN-12	703012
P2 d=31,7 DN-12	753112
P2 d=31,7 DN-16	753116
P1 d=38,1 DN-16	703816
P1 d=41,2 DN-16	704116
P2 d=38,1 DN-19	703819
P2 d=41,2 DN-19	754119
P2 d=41,2 CAT DN-19	7754119
P2 d=44,5 DN-19	704419
P2 d=47,6 DN-19	754719
P2 d=47,6 CAT DN-19	7754719
P2 d=54 DN-19	755419
P2 d=41,2 DN-25	754125
P2 d=44,5 DN-25	704425
P2 d=47,6 DN-25	754725
P2 d=47,6 CAT DN-25	7754725
P1 d=50,8 DN-25	705025
P2 d=54 DN-25	755425
P2 d=54 CAT DN-25	7755425
P1 d=50,8 DN-32	705032
P2 d=54 DN-32	755432
P1 d=60,3 DN-32	706032
P2 d=63,5 DN-32	756332
P1 d=60,3 DN-40	706040
P2 d=63,5 DN-40	756340
P1 d=71,5 DN-50	707150
P2 d=79,3 DN-50	757950

P/90 PRIKLJUČKI

NAZIV	IDENT
P1/90 d=30,2 DN-12	713012
P2/90 d=31,7 DN-12	763112
P2/90 d=31,7 DN-16	763116
P1/90 d=38,1 DN-16	713816
P1/90 d=41,2 DN-16	714116
P2/90 d=38,1 DN-19	713819
P2/90 d=41,2 DN-19	764119
P2/90 d=41,2 CAT DN-19	7764119
P2/90 d=44,5 DN-19	714419
P2/90 d=47,6 DN-19	764719
P2/90 d=47,6 CAT DN-19	7764719
P2/90 d=54 DN-19	765419
P2/90 d=41,2 DN-25	764125
P2/90 d=44,5 DN-25	714425
P2/90 d=47,6 DN-25	764725
P2/90 d=47,6 CAT DN-25	7764725
P1/90 d=50,8 DN-25	715025
P2/90 d=54 DN-25	765425
P2/90 d=54 CAT DN-25	7765425
P1/90 d=50,8 DN-32	715032
P2/90 d=54 DN-32	765432
P1/90 d=60,3 DN-32	716032
P2/90 d=63,5 DN-32	766332
P1/90 d=60,3 DN-40	716040
P2/90 d=63,5 DN-40	766340
P1/90 d=71,5 DN-50	717150
P2/90 d=79,3 DN-50	767950

P/45 PRIKLJUČKI

NAZIV	IDENT
P1/45 d=30,2 DN-12	723012
P2/45 d=31,7 DN-12	773112
P2/45 d=31,7 DN-16	773116
P1/45 d=38,1 DN-16	723816
P1/45 d=41,2 DN-16	724116
P2/45 d=38,1 DN-19	723819
P2/45 d=41,2 DN-19	774119
P2/45 d=41,2 CAT DN-19	7774119
P2/45 d=44,5 DN-19	724419
P2/45 d=47,6 DN-19	774719
P2/45 d=47,6 CAT DN-19	7774719
P2/45 d=54 DN-19	775419
P2/45 d=41,2 DN-25	774125
P2/45 d=44,5 DN-25	724425
P2/45 d=47,6 DN-25	774725
P2/45 d=47,6 CAT DN-25	7774725
P1/45 d=50,8 DN-25	725025
P2/45 d=54 DN-25	775425
P2/45 d=54 CAT DN-25	7775425
P1/45 d=50,8 DN-32	725032
P2/45 d=54 DN-32	775432
P1/45 d=60,3 DN-32	726032
P2/45 d=63,5 DN-32	776332
P1/45 d=60,3 DN-40	726040
P2/45 d=63,5 DN-40	776340
P1/45 d=71,5 DN-50	727150
P2/45 d=79,3 DN-50	777950

P/135 PRIKLJUČKI LIEBHERR

NAZIV	IDENT
P/135 d=41,2 DN-19	784119
P/135 d=47,6 DN-25	784725
P/135 d=54 DN3	785432

V proizvodnji se izdelujejo priključki za

- KOMATSU,
- CATERPILLAR
- KOBELCO
- MF
- ICB.....